



## Quick Start Guide







## Quick Start Guide

First Network Group Inc  
1-800-578-6381  
[www.DHCPatriot.com](http://www.DHCPatriot.com)



**The DHCPatriot is a broadband subscriber authentication device designed to give network administrators the same visibility on DHCP networks they once had on dial networks.**

### Introduction

This quick start guide will help experienced IT personnel get the DHCPatriot up and running in a short time. If more detailed instructions are required, please refer to the installation instructions in the full manual. Follow the steps in the order presented below. Please note that although steps 14 and 15 are both labeled as optional, one or the other must be performed to complete the setup of the DHCPatriot system.

### 1) Racking the Devices

Use four or six customer supplied rack screws to rack each device in a 19 inch two or four post rack as shown in the illustration.

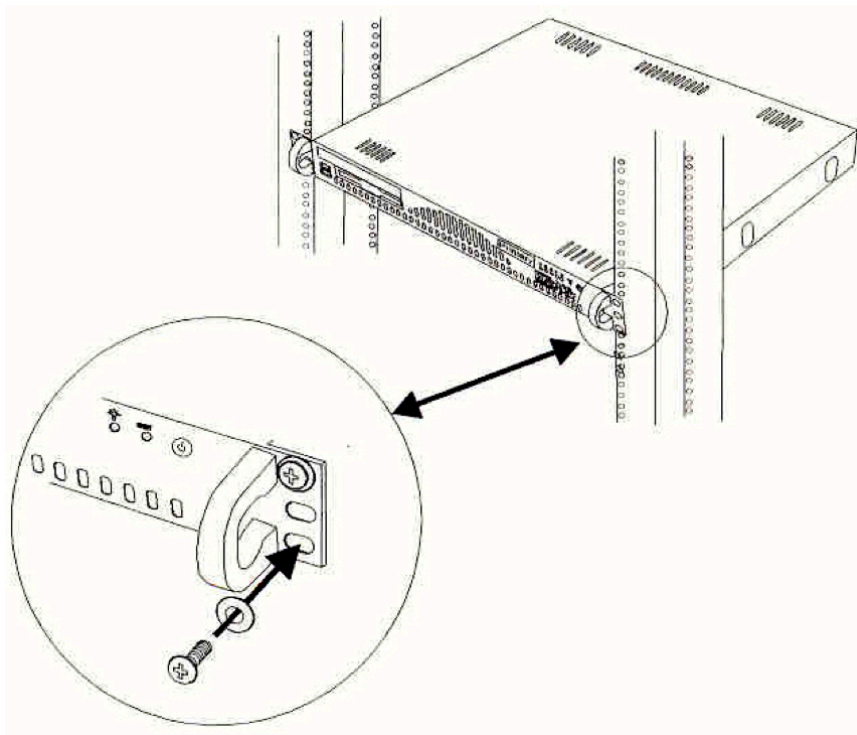

*Racking the DHCPatriot device*

## 2) Cabling the Devices

Run standard ethernet cabling from LAN 1 on each device to the desired switch. Connect the supplied red crossover cable to LAN 2 on each device. Connect the supplied power cables from each device to an AC power source. Connect serial console using the supplied serial console shells, if desired. See the illustration below.

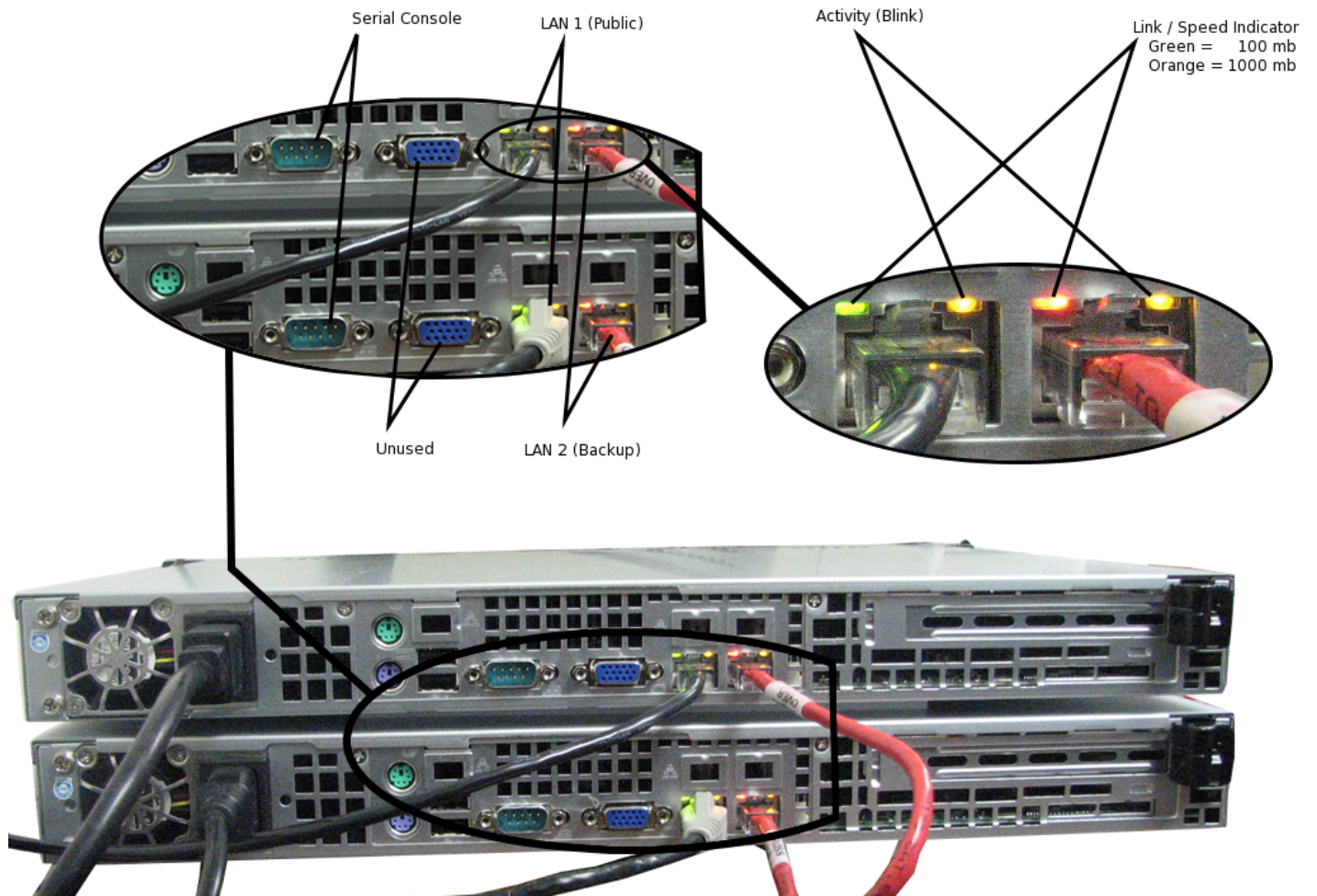

*Cabling the DHCPatriot devices*



### 3) Power on the devices

On the front of the devices, press the power button to turn them on. It may appear that they are already on due to the network indicators being lit, however, if the power light is not lit, they are not powered on. The lights and buttons are explained in the illustration below.

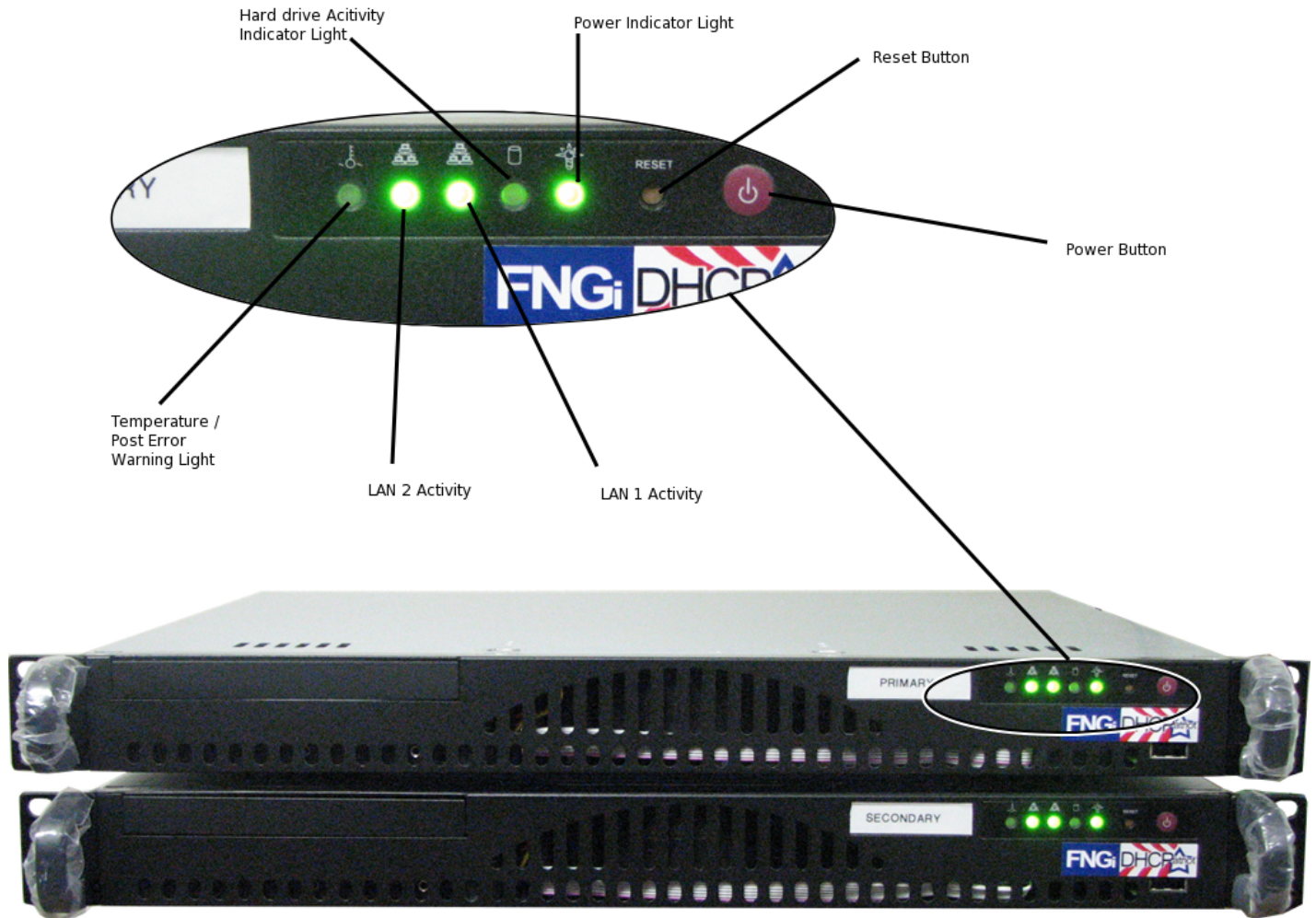

*DHCPatriot front panel buttons and indicators*

#### 4) Connect to the Devices

The devices can be accessed via SSH or serial console. The username is 'admin', and the password is 'cU\$0gNn1'. The fourth character is a zero. A menu interface will appear as shown in the illustration.

```

DHCPatriot v.4.0.0-AAA-Alpha
System Setup v.1.0.0
2002-2006 First Network Group, Inc. All Rights Reserved.
-----
Main Menu
1) View sample DNS/Router configs      2) View current system settings
3) Configure IP Address                 4) Configure Domain Name
5) Configure speed and duplex           6) Change Admin Password
7) Firewall Administration             8) Web Admin Account Setup
9) Ping                                 10) Trace
11) Restart                             12) Shutdown
0) Exit

Choice: █

Main Menu: CTRL-e                               Exit: CTRL-x
```

*DHCPatriot Console Menu Configuration Interface*

#### 5) Configure IP Address

Press 3 to enter IP address configuration. Press 1 to proceed. Enter the IP address, the netmask and the gateway. Press 1 to proceed. This will need to be done on each device.

#### 6) Configure Domain Name

Press 4 to enter the domain name configuration area. Press 1 then enter the domain name. Enter only the domain, DO NOT enter patriot, patriot-1 or patriot-2. Then press 1. Press enter. You should return to the main menu. This will need to be done on each device.

#### 7) Set Speed and Duplex

Change speed and duplex (ethernet media settings) on the main interface, if necessary. This will need to be done on each device, if necessary. Default is auto-negotiation.

#### 8) Open the Firewall

Press 7 to allow an IP address or network through the firewall. The important ports would be 22 (SSH), 80 (HTTP), and 443 (HTTPS). This is to allow a machine to access the DHCPatriot system for administration purposes. The system defaults to not letting anything through, so at least one machine will need to be allowed prior to rebooting after setting the IP address. This only needs to be performed on one device.

## 9) Add Account for Web Administration

Press 8 to enter an account for web administration. The remainder of the setup is performed via the web interface. Enter a username and password that you'll remember. Set the admin level to 6. This only needs to be performed on one device.

## 10) Reboot

Press 11 to reboot. Press 1 to proceed. When the device comes back up it will be at the new IP address and domain set previously. This will need to be done on each device.

## 11) Configuring DNS

Your DNS server needs to be configured for the new DHCPatriot system devices that have just been configured. Set a DNS entry of patriot.<domain you entered> pointing to both IP addresses that were set in the previous steps. Also create matching forward and reverse entries of patriot-1.<domain> and patriot-2.<domain> corresponding to the IP addresses entered previously.

## 12) Connect to Web Interface

The DHCPatriot system will be reachable at <https://patriot.<domain>>. Enter your username and password. You should receive a screen that looks similar to the illustration below.

The screenshot shows the DHCPatriot web administration interface. At the top right, it displays the version '5.0.0-TITLE-BETA-01' and an 'Online Manual' link. Below this, system statistics are shown: 'IP in use' (9), 'Max% of IP max' (3,360), and '0%'. The main header includes a welcome message for 'Darren L. Ankney' and the location 'Main -> Home'. A navigation menu on the left lists various system management options. The central content area is titled 'DHCPatriot News' and contains two news items. The first item, dated 2011-05-17 11:13:17, announces that version 5.0.0 has entered beta. The second item, dated 2011-01-28 13:50:32, provides a preview of version 5. Both news items are signed by Darren.

*Web Administration Screen after logging in.*

## 13) General Configuration

Expand the System Configuration menu and click General Setup. This will begin the initial configuration. Click Edit Settings. Make changes as necessary and Commit.

## 14) Add a Network for Authenticated DHCP (Optional)

Expand the Authenticated DHCP Menu and click on Shared Network. Add a Shared Network. Using Unauthenticated Subnet, add at least one unauthenticated subnet. Using Authenticated subnet, add at least one authenticated subnet. Enter static, and maintenance subnets using Static and Maintenance Subnet routines as necessary. Enter these subnets on the appropriate interface of the customer facing router. Add a policy route or multiple policy routing entries to send the unauthenticated traffic to the primary DHCPatriot device.

## 15) Add a Network for Standard DHCP (Optional)

Expand the standard DHCP menu. Click shared network config and add a network. Add dynamic, static, or maintenance networks as needed. If only known hosts are allowed in the dynamic, then add known hosts in known client config. If a static subnet is configured, but sure to assign some static assignments under static IP assignment.

---

This document Copyright ©2009  
First Network Group Inc.  
<http://www.network1.net>  
4-6 Perry St.  
P.O. Box 1662  
Wapakoneta, OH 45895

DHCPatriot™ is a trademark of First Network Group Inc. (<http://www.network1.net>)  
All other names and brands are protected by their respective companies.







© Copyright 2002-2011  
First Network Group Inc  
4-6 Perry St.  
PO Box 1662  
Wapakoneta, OH 45895  
[DHCPatriot@network1.net](mailto:DHCPatriot@network1.net)  
800-578-6381 opt. 3

DHCPatriot™ is a trademark of First Network Group Inc. (<http://www.network1.net>)  
All other names and brands are protected by their respective companies.